



Automotive Current-Sense Amplifier with Reverse-Battery Protection

MAX9937

General Description

The MAX9937 is a tiny automotive grade current-sense amplifier designed for unidirectional high-side current-sense applications. This device addresses major areas of concern for automotive applications including load-dump protection up to +40V, reverse-battery protection, and filtering for EMI and transient performance.

The MAX9937 also features a low input offset voltage of $\pm 1.2\text{mV}$ (max) at +25°C with a low temperature drift of just $1\mu\text{V}/^\circ\text{C}$ (typ).

The MAX9937 is available in a 5-pin SC70 package and is rated over the -40°C to +125°C temperature range.

Features

- ◆ Reverse Battery and Load-Dump Protection -20V to +40V
- ◆ +4V to +28V Input Common-Mode Range
- ◆ Flexible EMI Filtering
- ◆ Low V_{OS} : $\pm 1.2\text{mV}$ (max)
- ◆ Low V_{OS} Drift: $1\mu\text{V}/^\circ\text{C}$ (typ)
- ◆ 20 μA Supply Current
- ◆ 350kHz, 3dB Small Signal Bandwidth

Applications

Automotive Battery Current Sense
Fuse Box Current Sense
ECU Current Monitor

Ordering Information

PART	TEMP RANGE	PIN-PACKAGE	TOP MARK
MAX9937AXK+T	-40°C to +125°C	5 SC70	+ATB

+ Denotes a lead-free/RoHS-compliant package.

T = Tape and reel.

Pin Configuration appears at end of data sheet.

Typical Application Circuit

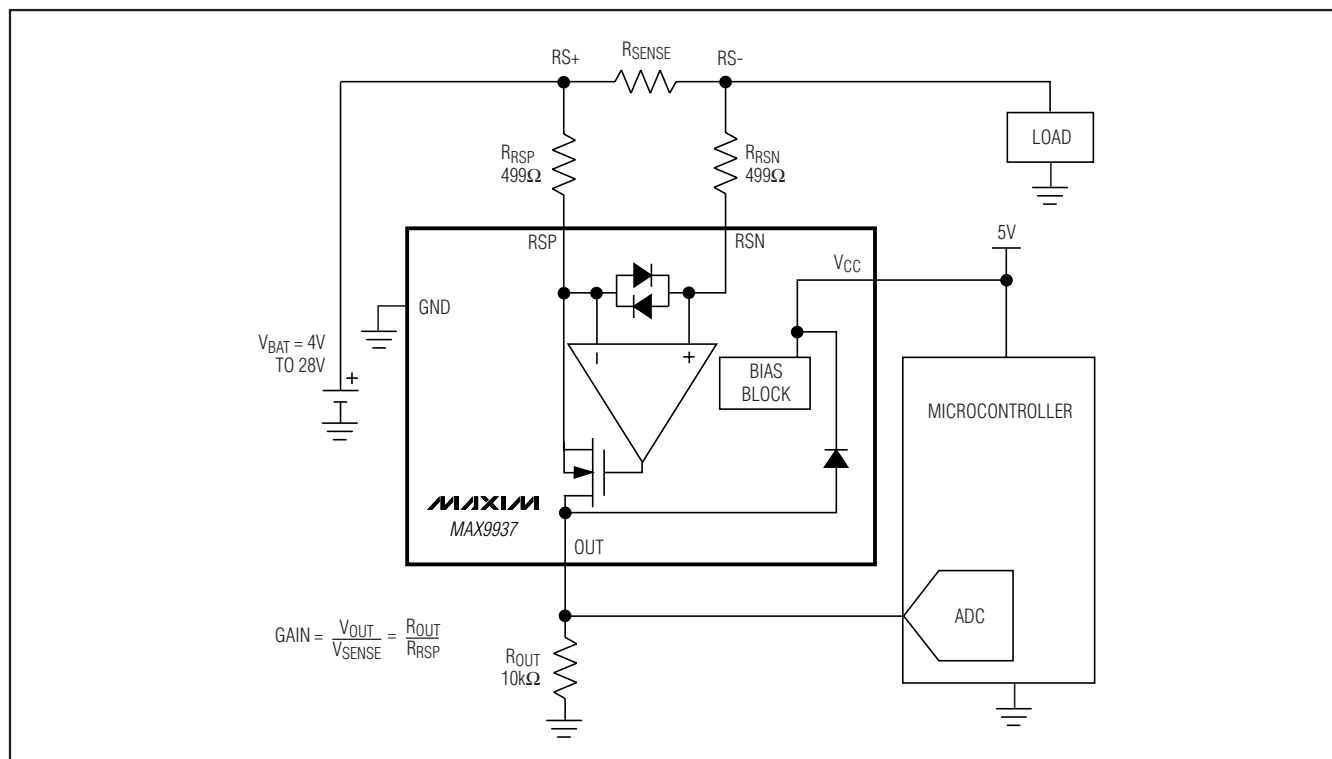

Automotive Current-Sense Amplifier with Reverse-Battery Protection

ABSOLUTE MAXIMUM RATINGS

RSP, RSN to GND Voltage Continuous	-0.3V to +30V
RSP, RSN to GND Load-Dump Voltage Duration (V _{BAT} = 40V) with <i>Typical Application Circuit</i>	1s
RSP, RSN to GND Reverse-Battery Voltage Duration (V _{BAT} = -20V) with <i>Typical Application Circuit</i>	Continuous
Differential Input Voltage (RSP - RSN)	±0.3V
V _{CC} to GND	-0.3V to +6.0V
OUT to GND	-0.3V to (V _{CC} + 0.3V)
Output Short Circuit to Ground	Continuous
Continuous Input Current into RSN, RSP*	±50mA
Continuous Input Current into OUT*	±25mA

Thermal Limits (Note 1)	
5 SC70 Multiple-Layer PCB	
Continuous Power Dissipation (T _A = +70°C) (derate 3.1mW/°C above +70°C)	246.9mW
θ _{JA}	324°C/W
θ _{JC}	115°C/W
Operating Temperature Range	-40°C to +125°C
Junction Temperature	+150°C
Lead Temperature (soldering, 10s)	+300°C
Lead Temperature (reflow)	+260°C

Note 1: Package thermal resistances were obtained using the method described in JEDEC specification JESD51-7, using a 4-layer board. For detailed information on package thermal considerations, refer to www.maxim-ic.com/thermal-tutorial.

*Junction temperature rating due to power dissipation must also be observed.

Stresses beyond those listed under "Absolute Maximum Ratings" may cause permanent damage to the device. These are stress ratings only, and functional operation of the device at these or any other conditions beyond those indicated in the operational sections of the specifications is not implied. Exposure to absolute maximum rating conditions for extended periods may affect device reliability.

ELECTRICAL CHARACTERISTICS

(V_{CC} = 5V, V_{BAT} = V_{RS+} = 12V, V_{SENSE} = (V_{RS+} - V_{RS-}) = 0, R_{RSP} = R_{RSN} = 500Ω, R_{OUT} = 10kΩ, T_A = -40°C to +125°C. Typical values are at T_A = +25°C, unless otherwise noted. See the *Typical Application Circuit*.) (Note 2)

PARAMETER	SYMBOL	CONDITIONS	MIN	TYP	MAX	UNITS	
DC CHARACTERISTICS							
Input Common-Mode Voltage Range	V _{RSP} , V _{RSN}	Inferred from CMRR test	4		28	V	
Supply Voltage Range	V _{CC}	Inferred from PSRR test	2.7		5.5	V	
Input Offset Voltage (Note 3)	V _{OS}	T _A = +25°C		±0.3	±1.2	mV	
		T _A = -40°C to +125°C			±1.6		
Common-Mode Rejection Ratio	CMRR	V _{BAT} = +4V to +28V	T _A = +25°C	100	120	dB	
			T _A = +125°C	90			
Power-Supply Rejection Ratio	PSRR	V _{CC} = +2.7V to +5.5V	90	120		dB	
Quiescent Supply Current	I _{CC}	V _{CC} = 5V		20	55	μA	
Input Bias Current (Note 4)	I _{B+} , I _{B-}	T _A = +25°C	0.8	2	5.6	μA	
		T _A = -40°C to +125°C	0.65		6.5		
Input Bias Current Mismatch	ΔI _B / I _B	2 × (I _{B+} - I _{B-}) / (I _{B+} + I _{B-})	T _A = +25°C		±1	±12	%
			T _A = -40°C to +125°C			±15	%
Input Current in Shutdown	I _{RSP} + I _{RSN}	T _A = +25°C, V _{CC} = 0		0.01	1	μA	
		T _A = -40°C to +125°C, V _{CC} = 0			10		
Voltage Gain		Gain = R _{OUT} /R _{RSP}		20		V/V	
Voltage Gain Error (Notes 3, 5)		T _A = +25°C		±0.2	±1.5	%	
		T _A = -40°C to +125°C			±2.0		

Automotive Current-Sense Amplifier with Reverse-Battery Protection

MAX9937

ELECTRICAL CHARACTERISTICS (continued)

($V_{CC} = 5V$, $V_{BAT} = V_{RS+} = 12V$, $V_{SENSE} = (V_{RS+} - V_{RS-}) = 0$, $R_{RSP} = R_{RSN} = 500\Omega$, $R_{OUT} = 10k\Omega$, $T_A = -40^{\circ}C$ to $+125^{\circ}C$. Typical values are at $T_A = +25^{\circ}C$, unless otherwise noted. See the *Typical Application Circuit*.) (Note 2)

PARAMETER	SYMBOL	CONDITIONS	MIN	TYP	MAX	UNITS
Maximum Output Current	I_{OUT}	$R_{RSN} = 500\Omega$, $R_{RSP} = 0$, $V_{OUT} = 0$	2	7.5	22	mA
Output-Voltage Compliance (Note 6)		$V_{SENSE} = 500mV$, $\Delta I_{OUT} \leq 1\%$	-0.1		$V_{CC} + 0.1$	V
		$V_{BAT} = 4V$, $V_{SENSE} = 0.1V$, $\Delta I_{OUT} \leq 2\%$	-0.1	$V_{RSP} - 0.15$	$V_{RSP} - 0.8$	
Output-Voltage High	V_{OH}	$V_{BAT} = 4V$, $V_{SENSE} = +500mV$, $V_{OH} = V_{BAT} - V_{OUT}$		0.4	1.2	V
Output-Voltage Low	V_{OL}	$V_{BAT} = 4V$, $V_{SENSE} = -100mV$		2	20	mV
AC CHARACTERISTICS						
3dB Large-Signal Bandwidth	BW	$V_{SENSE} = 137.5mV_{DC} + 225mV_{P-P}$		250		kHz
3dB Small-Signal Bandwidth				350		kHz
Settling Time to 1%	t_S			5		μs
Input-Voltage Noise	e_n	$f = 1kHz$		28		nV/ \sqrt{Hz}
Input Current Noise	I_n	$f = 1kHz$		1		pA/ \sqrt{Hz}

Note 2: All devices are 100% production tested at $T_A = +25^{\circ}C$. Temperature limits are guaranteed by design.

Note 3: Gain and offset voltage are calculated based on two point measurements: $V_{SENSE1} = 5mV$ and $V_{SENSE2} = 200mV$.

Note 4: Input bias current I_{B+} and I_{B-} refers to the internal op amp's inputs (inverting and noninverting) so that $I_{B-} = I_{RSN}$ and $I_{B+} = I_{RSP} - I_{OUT}$.

$$I_B = \frac{I_{B+} + I_{B-}}{2}$$

$$\Delta I_B = |I_{B+} - I_{B-}|$$

Note 5: The gain is set by the external resistors R_{RSP} and R_{OUT} . See the *Typical Application Circuit*.

Note 6: $V_{RSP} = V_{BAT} - V_{SENSE} - V_{OS} - (R_{RSN} \times I_{B-})$.

Automotive Current-Sense Amplifier with Reverse-Battery Protection

Typical Operating Characteristics

($V_{CC} = 5V$, $V_{BAT} = V_{RSP} = 12V$, $V_{SENSE} = V_{RS+} - V_{RS-} = 0$, $R_{RSP} = R_{RSN} = 500\Omega$, $R_{OUT} = 10k\Omega$, $T_A = +25^\circ C$, unless otherwise noted. See the *Typical Application Circuit*.)

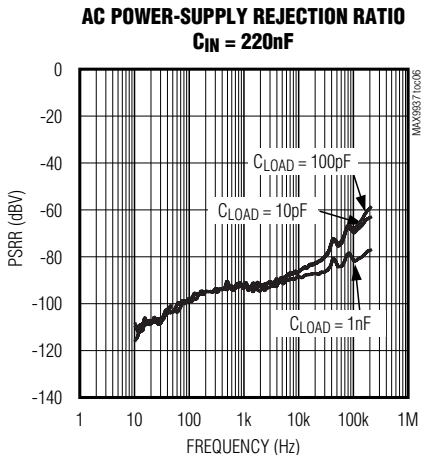
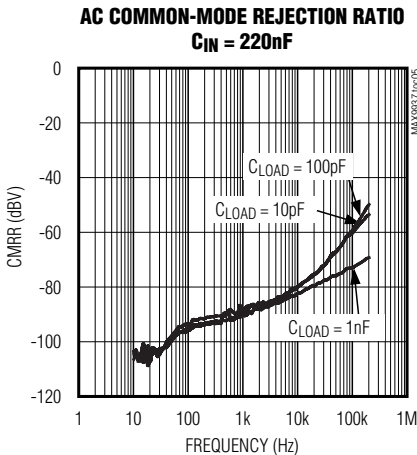
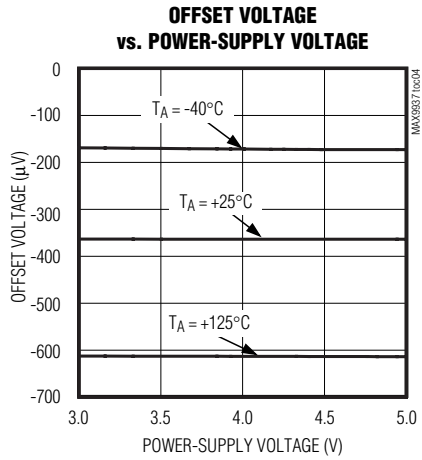
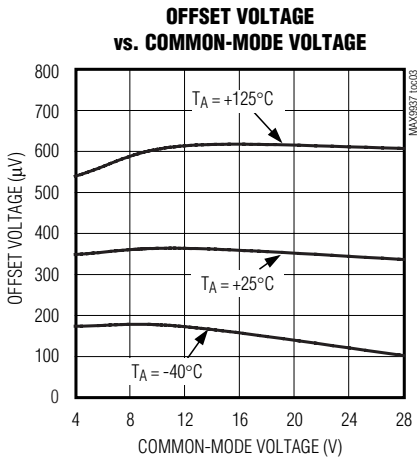
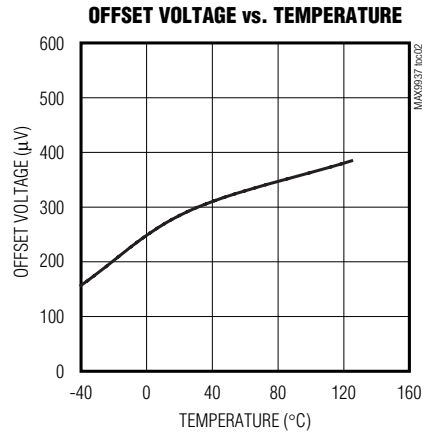
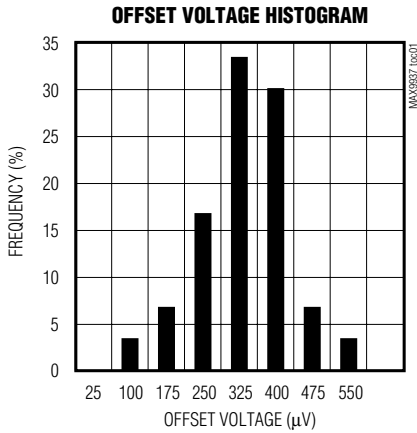

Automotive Current-Sense Amplifier with Reverse-Battery Protection

MAX9937

Typical Operating Characteristics (continued)

($V_{CC} = 5V$, $V_{BAT} = V_{RSP} = 12V$, $V_{SENSE} = V_{RS+} - V_{RS-} = 0$, $R_{RSP} = R_{RSN} = 500\Omega$, $R_{OUT} = 10k\Omega$, $T_A = +25^\circ C$, unless otherwise noted. See the *Typical Application Circuit*.)

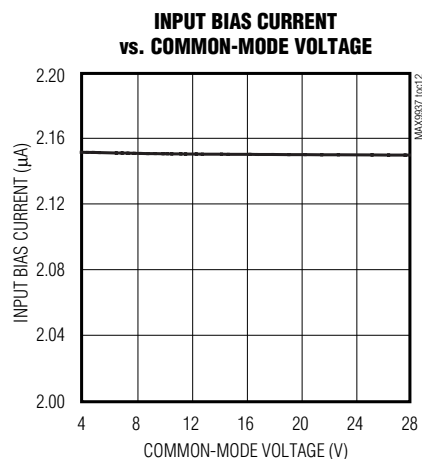
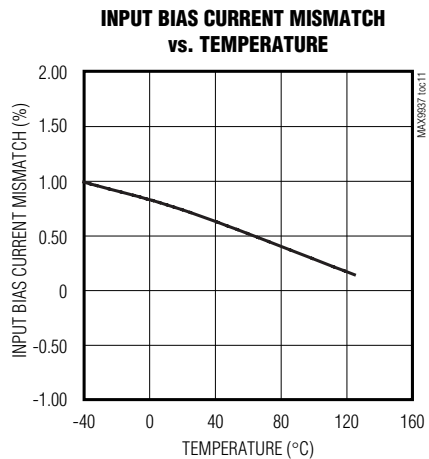
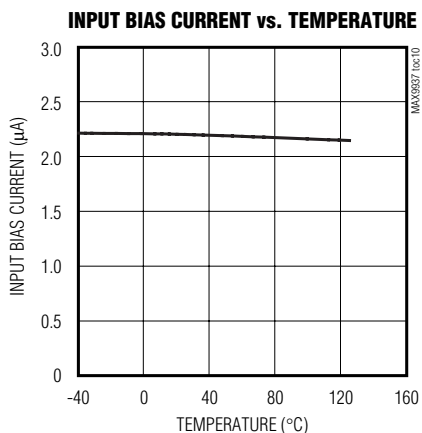
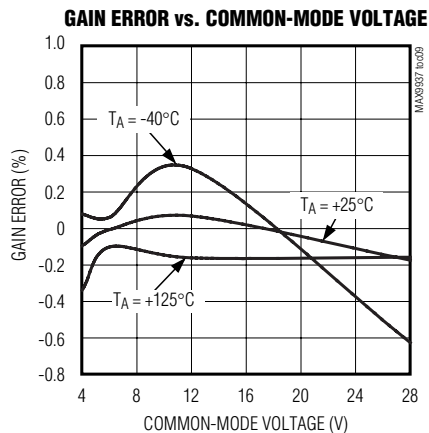
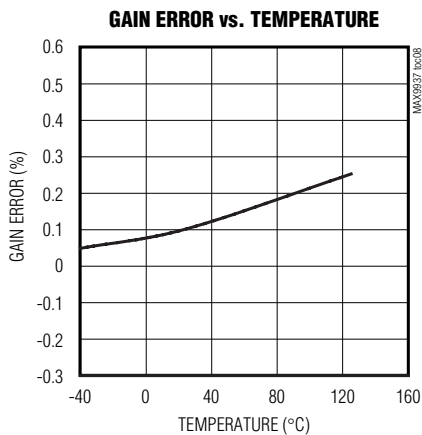
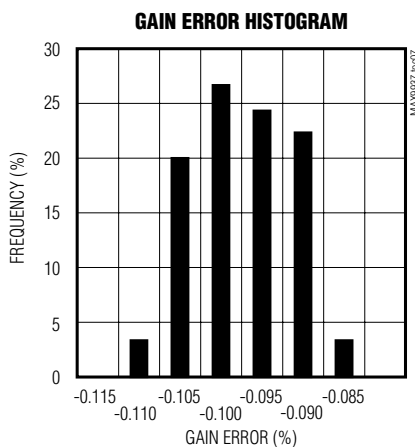

Automotive Current-Sense Amplifier with Reverse-Battery Protection

Typical Operating Characteristics (continued)

($V_{CC} = 5V$, $V_{BAT} = V_{RSP} = 12V$, $V_{SENSE} = V_{RS+} - V_{RS-} = 0$, $R_{RSP} = R_{RSN} = 500\Omega$, $R_{OUT} = 10k\Omega$, $T_A = +25^\circ C$, unless otherwise noted. See the *Typical Application Circuit*.)

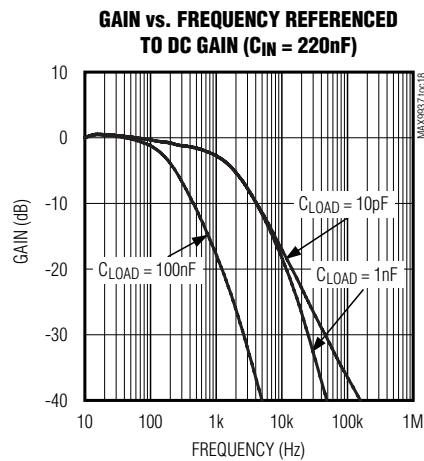
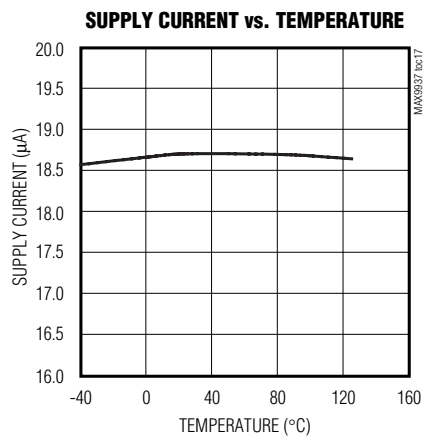
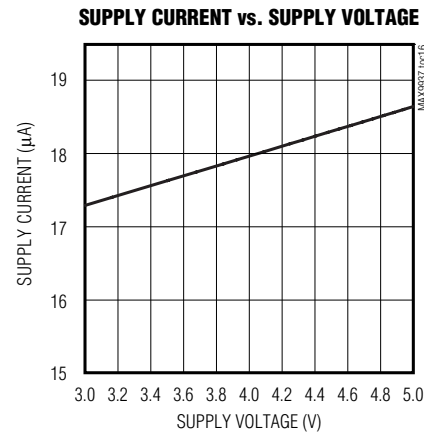
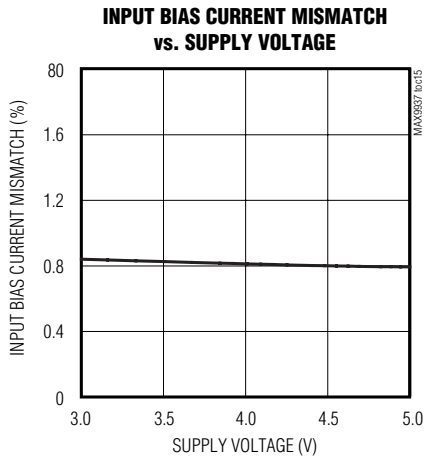
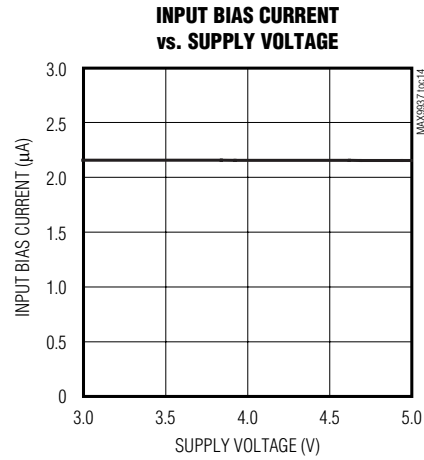
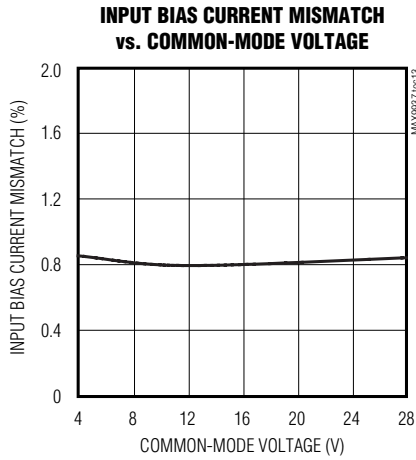

Automotive Current-Sense Amplifier with Reverse-Battery Protection

MAX9937

Typical Operating Characteristics (continued)

($V_{CC} = 5V$, $V_{BAT} = V_{RSP} = 12V$, $V_{SENSE} = V_{RS+} - V_{RS-} = 0$, $R_{RSP} = R_{RSN} = 500\Omega$, $R_{OUT} = 10k\Omega$, $T_A = +25^\circ C$, unless otherwise noted. See the *Typical Application Circuit*.)

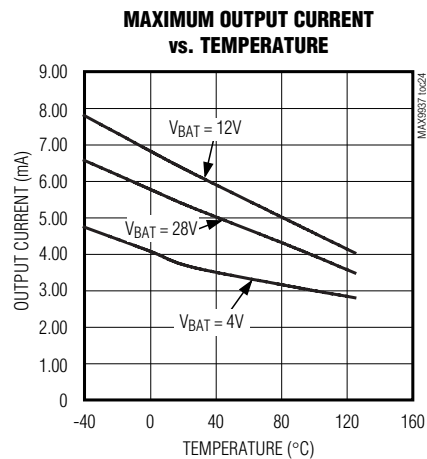
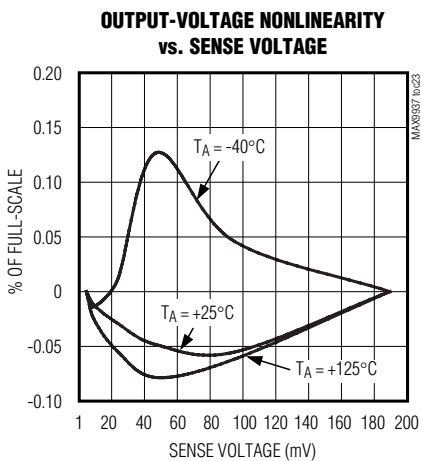
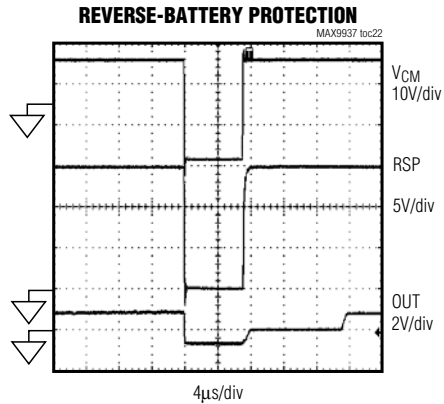
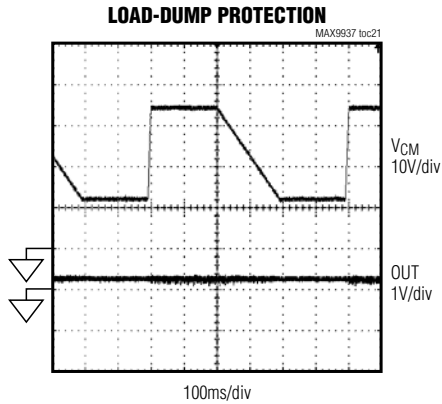
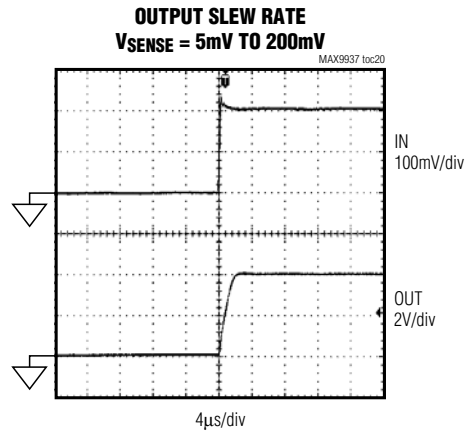
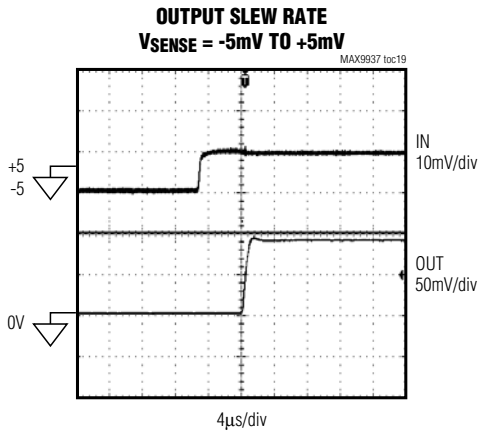

Automotive Current-Sense Amplifier with Reverse-Battery Protection

Pin Description

PIN	NAME	FUNCTION
1	VCC	Power Supply. Bypass to GND with a 0.1µF capacitor.
2	GND	Ground
3	OUT	Current Output
4	RSN	Load-Side Connection Through External R _{RSN} Resistor
5	RSP	Supply-Side Connection Through External R _{RRSP} Resistor

Detailed Description

The MAX9937 unidirectional high-side, current-sense amplifier features a 4V to 28V input common-mode voltage range that is independent of supply voltage (VCC = 2.7V to 5.5V). The MAX9937 monitors the current through a current-sense resistor by converting the sense voltage to a current output (OUT). Gain is set by the ratio of an output resistor (R_{OUT}) and an input resistor (R_{RRSP}). High-side current monitoring with the MAX9937 does not interfere with the ground path of the load, making it useful for a variety of automotive battery/ECU monitoring.

Robust input ESD structure allows input common-mode voltages to exceed the 28V maximum operating input range for short durations, making the MAX9937 ideal for applications that need to withstand short-duration load-dump conditions. The MAX9937 is able to withstand reverse-battery conditions by a suitable choice of input resistors (R_{RSN}, R_{RRSP}). See the *Input Common-Mode Voltages > 28V and < 0V* section.

Current-Sense Amplifier Operation

The MAX9937 current-sense amplifier operation is best understood as a specialized op-amp circuit with a p-channel FET in the feedback path. The op amp forces a current through an external gain resistor at RSP (R_{RRSP}, see the *Typical Application Circuit*) so that its voltage drop equals the voltage drop across the external sense resistor, R_{SENSE}, making the voltage at RSP the same as RSN. An external resistor at RSN (R_{RSN}) has the same value as R_{RRSP} to minimize input offset voltage due to input bias currents.

The current through R_{RRSP} is now sourced by the high-voltage p-channel FET into an external resistor (R_{OUT}) at OUT. This produces an output voltage whose magnitude is given by the following equations:

$$V_{\text{SENSE}} = I_{\text{LOAD}} \times R_{\text{SENSE}}$$

$$V_{\text{OUT}} = V_{\text{SENSE}} \times \frac{R_{\text{OUT}}}{R_{\text{RRSP}}}$$

The gain accuracy is primarily determined by the matching of the two gain resistors, R_{RRSP} and R_{OUT}. The voltage gain error of the MAX9937 is less than 1.5%.

$$\text{Total gain} = 20\text{V/V with } R_{\text{OUT}} = 10\text{k}\Omega \\ \text{and } R_{\text{RRSP}} = 500\Omega.$$

Low temperature drift of input bias currents and input offset currents minimizes their impact on total input offset voltage of the current-sense amplifier.

Applications Information

Choosing R_{SENSE}

To measure lower currents more accurately, use a high value for R_{SENSE}. The high value develops a higher sense voltage that reduces the effect of offset voltage errors of the internal op amp. In applications monitoring very high currents, however, R_{SENSE} must be able to dissipate the I²R losses. If the resistor's rated power dissipation is exceeded, its value may drift or it may fail altogether, causing large differential voltages to develop between RSP and RSN.

To minimize the effect of input offset voltage by production calibration, see the *Skewed Input Offset Voltage for Production Calibration* section. This can help reduce the size of the sense resistor in high-current applications, as well as measure wide-dynamic-range currents without sacrificing accuracy.

If I_{SENSE} has a large high-frequency component, minimize the inductance of R_{SENSE} and use input differential filters (see the *Flexible EMI Filtering* section). Low-inductance metal-film resistors are best suited for these applications.

Calculation of Total Input Offset Voltage

Because of the use of op-amp style architecture, calculation of total input offset voltage involves the same methodology as is used for any standard op-amp circuit. Interaction of the input bias currents and tolerance of the external resistors, combined with the core input offset voltage of the op amp, are important to consider. Finally, RSS (root-sum-of-squares) calculation for all these uncorrelated sources of error gives the final input offset voltage.

$$(V_{\text{OS-FINAL}})^2 = (V_{\text{OS}})^2 + (I_{\text{B}} \times \Delta R_{\text{RS}})^2 + (\Delta I_{\text{B}} \times R_{\text{RS}})^2$$

Automotive Current-Sense Amplifier with Reverse-Battery Protection

MAX9937

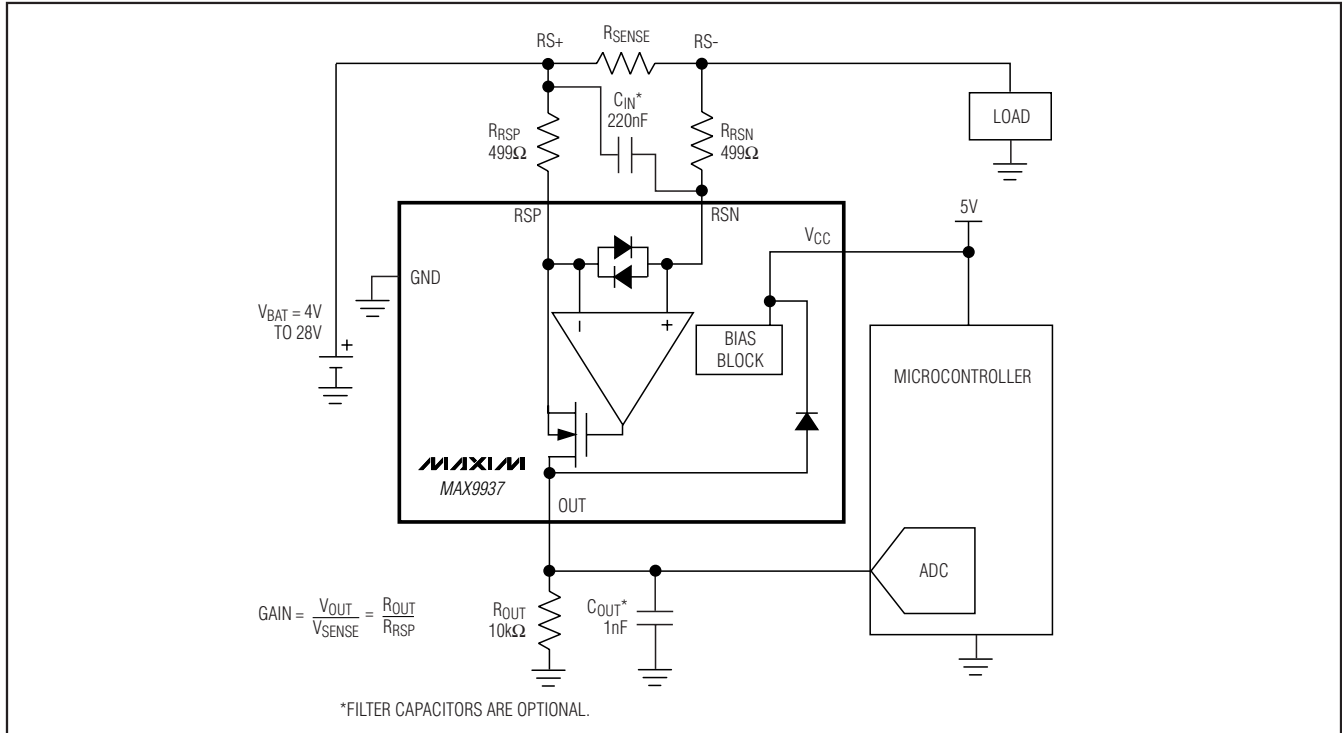

Figure 1. Typical Application Circuit with Optional External Filtering

In this case, $R_{RS} = R_{RS+} = R_{RSN}$, ΔR_{RS} depends on the tolerance of the R_{RS} resistors used, and $\Delta I_B =$ input offset current of the amplifier.

The temperature drift of these parameters similarly add up to give a final result.

Shown below is an example calculation of V_{OS} at $+25^\circ\text{C}$:

With $V_{OS} = \pm 1.2\text{mV}$ (max), $I_B = 5.6\mu\text{A}$ (max), $\Delta I_B = \pm 12\%$ (max) of $5.6\mu\text{A}$ (max) = $\pm 0.67\mu\text{A}$ (max), and $R_{RS} = 500\Omega$ with $\pm 1\%$ tolerance (i.e., $\Delta R_{RS} = \pm 5\Omega$ max)

$V_{OS-FINAL} = 1.25\text{mV}$ (max).

Flexible EMI Filtering

Real-world applications of current-sense amplifiers need to measure currents precisely in the presence of a wide variety of input transients. For example, fast load-current transients when measuring at the input of a switching buck regulator can cause high-frequency differential sense voltages to occur at inputs of the MAX9937, although the signal of interest is the average DC value. Alternately, parasitic voltage pickup on a disconnected or long cable can cause common-mode voltage transients to occur at inputs of the MAX9937, which are required to be rejected effectively.

The MAX9937 allows two methods of filtering to help improve performance in the presence of input common-mode voltage and input differential-voltage transients (see Figure 1).

The capacitor C_{IN} between $RS+$ and RSN helps filter against input differential voltages, and prevents them from reaching the MAX9937. The corner frequency of this filter is determined by the choice of R_{RSN} and C_{IN} .

$$f_{C-IN} = \frac{1}{2\pi R_{RSN} \times C_{IN}}$$

Similarly, capacitor C_{OUT} from OUT to ground helps filter the output voltage, thus providing not only differential filtering, but also filtering for input common-mode transients that have made it past the MAX9937. The corner frequency of this filter is similarly determined by choice of R_{OUT} and C_{OUT} . **Note:** The MAX9937 is a current-output device, and has the ability to drive an infinite amount of load capacitance.

$$f_{C-OUT} = \frac{1}{2\pi R_{OUT} \times C_{OUT}}$$

Automotive Current-Sense Amplifier with Reverse-Battery Protection

At frequencies below the output corner frequency, the MAX9937 itself provides excellent 100dB (DC) common-mode rejection. At higher frequencies, as the CMRR of the MAX9937 degrades, the output filter formed by R_{OUT} and C_{OUT} helps boost the common-mode rejection of the circuit.

Input Common-Mode Voltages > 28V and < 0V

Short-duration overvoltages on the battery line are isolated from the RSP and RSN pins of the MAX9937 by the use of input resistors R_{RSP} and R_{RSN} . The input ESD clamp structure is designed so that the device can withstand short-duration (< 1s) overvoltages up to 40V when using resistors R_{RSP} and R_{RSN} of 500 Ω or greater as shown in the *Typical Application Circuit*.

Approximately 40mA flows out of each ESD diode during this condition (20V/500 Ω). This current is less than the 50mA absolute maximum specification for the RSN and RSP pins.

Skewed Input Offset Voltage for Production Calibration

Due to low temperature drift of input bias current and input offset voltage in the MAX9937, the part can be used to provide powerful application and system benefits not normally attainable from other current-sense amplifiers on the market. For example, input resistors R_{RSP} and R_{RSN} can be intentionally mismatched so as to introduce an external, controlled input offset voltage into the circuit. Doing so allows microcontroller firmware to trim out input offset voltages completely by using production-line calibration during the manufacturing process or in system operation as long as a zero load-current condition is forced. Only minimal temperature-drift-based errors in the resistor and in the bias currents then remain.

$$V_{OS-FINAL} = V_{OS} + I_{B-} \times R_{RSN} - I_{B+} \times R_{RSP}$$

while gain = R_{OUT}/R_{RSP} .

Since gain can be fixed by choosing R_{OUT} and R_{RSP} , a positive offset voltage can be induced by varying the value of R_{RSN} compared to R_{RSP} .

For example:

$R_{OUT} = 10k\Omega$, $R_{RSP} = 500\Omega$ fixes gain = 20V/V. Now, choosing $R_{RSN} = 2.5k\Omega$, and knowing $\Delta I_{B-} = \pm 12\%$ of I_{B-} , the additional V_{OS} becomes:

$$\Delta V_{OS} (max) = (5.6\mu A \times 2500) \pm (0.12 \times 5.6\mu A \times 2500) - (5.6\mu A \times 500) = 11.2mV \pm 1.7mV$$

$$\Delta V_{OS} (min) = (0.8\mu A \times 2500) \pm (0.12 \times 0.8\mu A \times 2500) - (0.8\mu A \times 500) = 1.6mV \pm 0.24mV$$

Since the minimum extra V_{OS} introduced into the part is greater than the maximum V_{OS} of the current-sense amplifier (= 1mV), the output of the current-sense amplifier is always greater than zero even at zero sense voltage, thus allowing the current-sense amplifier to be calibrated at zero input current.

Operation with $V_{CC} = 0V$ (Shutdown)

The input terminals go into a high-impedance mode when $V_{CC} = 0$, as shown by the input bias current in shutdown 1 μA specification. Due to the low 20 μA supply current, this then becomes a convenient way to put the amplifier in shutdown simply by using a digital I/O port of a microcontroller to power up/down the current-sense amplifier. This can be especially useful in certain battery-operated applications that need to implement flexible power-management schemes.

Pin Configuration

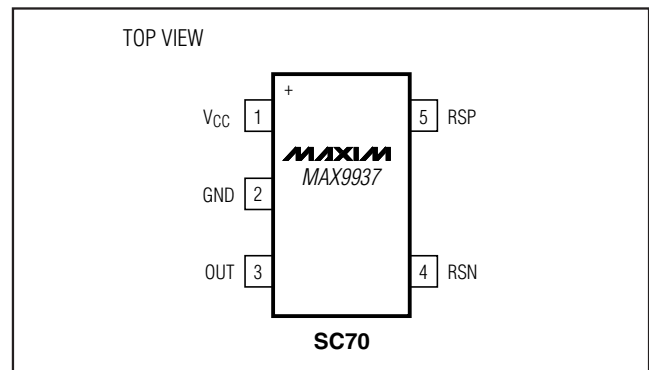

Chip Information

PROCESS: BiCMOS

Package Information

For the latest package outline information and land patterns, go to www.maxim-ic.com/packages.

PACKAGE TYPE	PACKAGE CODE	DOCUMENT NO.
5 SC70	X5+1	21-0076

Automotive Current-Sense Amplifier with Reverse-Battery Protection

Package Information (continued)

(The package drawing(s) in this data sheet may not reflect the most current specifications. For the latest package outline information go to www.maxim-ic.com/packages.)

MAX9937

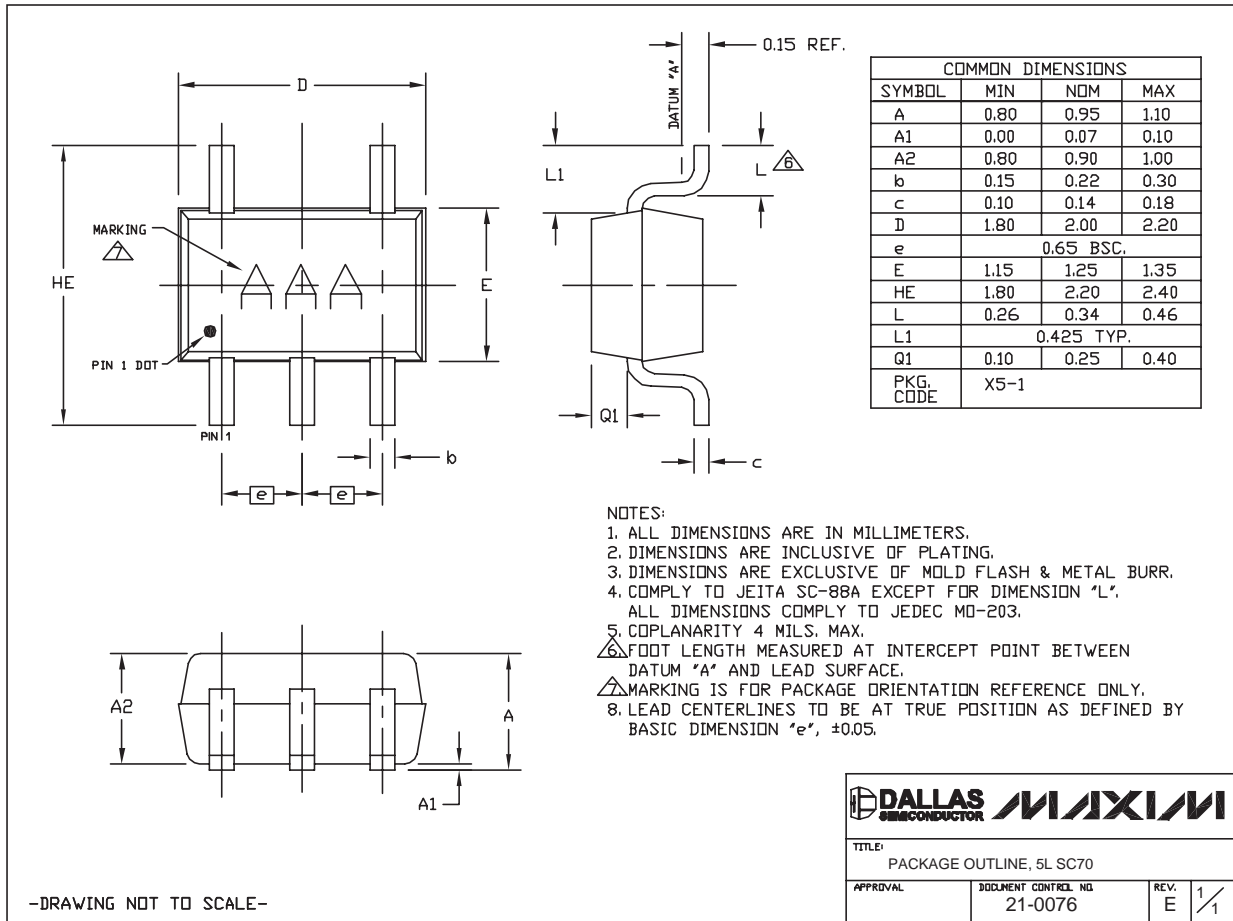

SC70, 5L EPS

Maxim cannot assume responsibility for use of any circuitry other than circuitry entirely embodied in a Maxim product. No circuit patent licenses are implied. Maxim reserves the right to change the circuitry and specifications without notice at any time.

Maxim Integrated Products, 120 San Gabriel Drive, Sunnyvale, CA 94086 408-737-7600 _____ 11